

Register your product and get support at  
[www.philips.com/welcome](http://www.philips.com/welcome)

SDV6224/12



---

EN User manual

---

**PHILIPS**



# Contents

---

<b>1 Important</b>	4
Safety	4
Recycling	4

---

<b>2 Your SDV6224/12</b>	5
Overview	5

---

<b>3 Get started</b>	6
Installation	6

---

<b>4 Set up SDV6224/12</b>	7
For VHF/FM reception	7
For UHF reception	7
Mount on the wall	7
Set up a digital tuner with this antenna	8

---

<b>5 Frequently asked questions</b>	9
-------------------------------------	---

---

<b>6 Warranty and service</b>	9
-------------------------------	---

---

<b>7 Glossary</b>	10
-------------------	----

# 1 Important

---

## Safety

This manual contains important information about the Philips indoor television antenna. Read it carefully before you start the installation and setup.

- The product shall not be exposed to dripping or splashing and that no objects filled with liquids, such as vases, shall be placed on the product.
- To completely disconnect the power input, the mains plug of the product shall be disconnected from the mains.
- Where the mains plug is used as the disconnect device, the disconnect device shall remain readily operable.
- No naked flame sources, such as lighted candles, should be placed on the product.

---

## Recycling



Your product is designed and manufactured with high quality materials and components, which can be recycled and reused.

When you see the crossed-out wheel bin symbol attached to a product, it means the product is covered by the European Directive 2002/96/EC:



Never dispose of your product with other household waste. Please inform yourself about the local rules on the separate collection of electrical and electronic products. The correct disposal of your old product helps prevent potentially negative consequences on the environment and human health.



When this logo is attached to a product, it means a financial contribution has been paid to the associated national recovery and recycling system.

© 2010 Koninklijke Philips Electronics N.V. All rights reserved. Reproduction in whole or in part is prohibited without the written consent of the copyright owner. Trademarks are the property of Koninklijke Philips Electronics N.V. or their respective owners.



## 2 Your SDV6224/12

Congratulations on your purchase and welcome to Philips!

To fully benefit from the support that Philips offers, register your product at [www.philips.com/welcome](http://www.philips.com/welcome).

### Overview

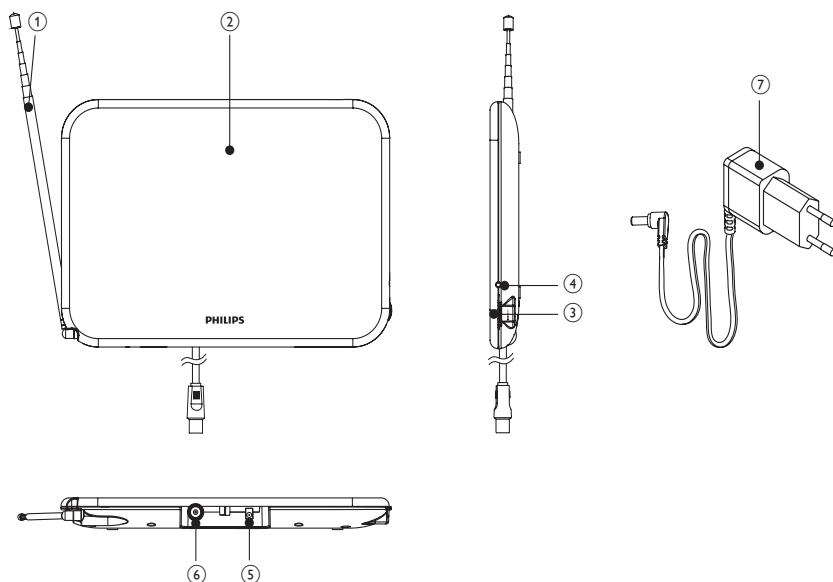

1	VHF antenna
2	UHF antenna
3	Power switch/gain control knob
4	Power indicator
5	6V DC connection
6	Out to TV connection
7	Power adaptor, included 100-240V AC / 6V DC

# 3 Get started

To ensure the antenna to work properly, read the user manual of your television before you start. Set the television so that it receives the signal from an ANTENNA instead of CABLE or SATELLITE.

- 2 Connect the DC plug to the antenna and the power supply to a 100-240V AC outlet.

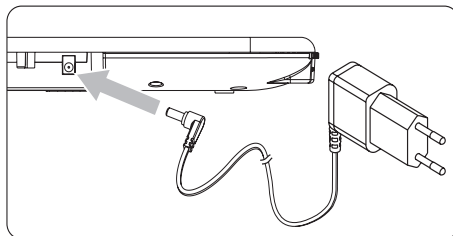

---

## Installation

### Determine the signal strength

Before Installation, determine the best location for optimum reception. It is important for the antenna to have an unobstructed path to the transmitter. For best results, ensure the antenna faces the location of the transmitter.

#### Note

- Choose a location near a window which gives the antenna a clear view of the transmitter.

#### Note

- Place the antenna away from the metal surface to avoid interference.

---

## Connect to the TV

- 1 Connect the signal output on the antenna to the TV.

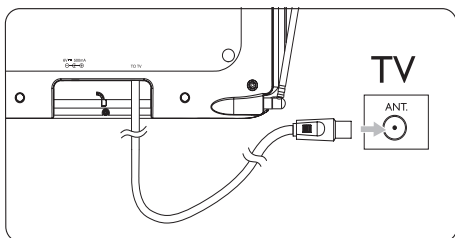

# 4 Set up SDV6224/12

## For VHF/FM reception

- 1 Extend the telescopic dipoles to the longest possible length.

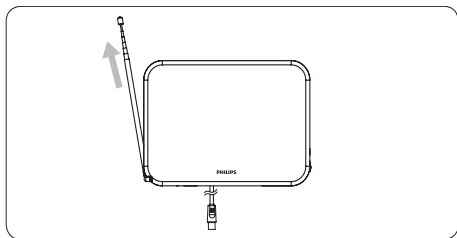

- 2 To turn the amplifier up, rotate the gain control knob towards the max position.

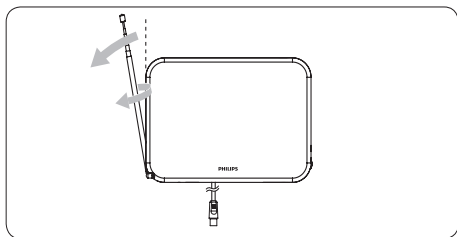

- 3 Turn the TV or FM radio to the desired channel/station. Move the dipoles in different directions up and down until the reception is achieved.

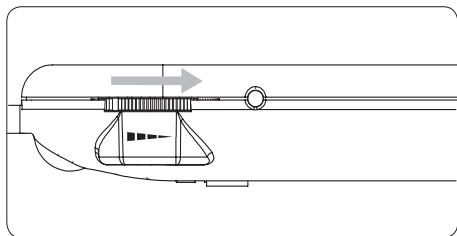

### Tip

- It is possible to turn the gain control knob down for best reception.

## For UHF reception

- 1 Turn the TV to the desired channel/station.
- 2 To turn the amplifier up, rotate the gain control knob towards the max position.

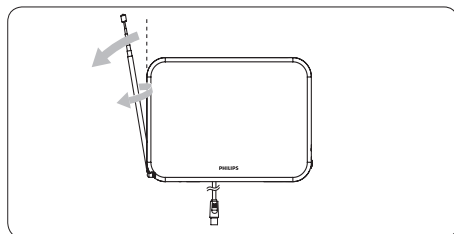

### Note

- It is possible to turn the gain control knob down for best reception.

## Mount on the wall

Mount two wood screws onto the wall. Ensure the distance between two screws is 80mm (3.149").

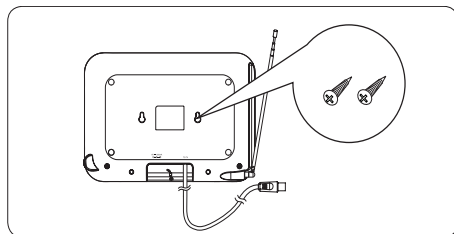

---

## Set up a digital tuner with this antenna

You can install available channels with the digital TV tuner. This automatic process is part of the setup of the tuner. Ensure the antenna has set up properly before the tuner can receive viewable channels.

There are two ways to connect the antenna to the TV:

- Connect the antenna to a digital tuner. If the signal strength is good enough, the channels can be memorized in the tuner automatically .
- Connect the antenna directly to the TV. Tune to the analogue channels and find the best antenna location. Then re-connect the antenna to the digital tuner. Ensure the signal strength is good enough before you install the channels with the tuner.



## 5 Frequently asked questions

### Can this antenna work with Analogue transmissions?

Yes, this antenna can receive analogue television broadcasts in the UHF and VHF bandwidths.

### Can this antenna receive digital or work with HD-DVB broadcasts?

Yes, this antenna is designed to receive digital DVB and HDTV broadcasts in the UHF & VHF bandwidths.

### Can the antenna be powered by a DC power supply in a boat, RV or camper?

Yes, there is a DC power socket located at the back of the antenna. Plug your cable/adaptor into the antenna and then into your power source.

### Where should I place the antenna in order to get the best reception possible?

Choose a location near a window which gives the antenna a clear view of the transmitter.



Tip

- For best reception, place the antenna away from the metal surface to avoid interference.

### How do I know how much gain (amplification) is required to receive a clear picture?

Once you have the VHF dipoles extended to the longest length, turn on the amplifier. Turn the amplifier up to the max position and then reduce as needed. In some case, you need to turn the amplifier down to receive a clearer picture.

### Can I set up this antenna with a digital tuner?

Yes, this antenna can be set up with a digital tuner (see the section on "Set up a digital tuner with this antenna").

## 6 Warranty and service

Warranty information can be found at: [www.philips.com/welcome](http://www.philips.com/welcome)

For technical support, send us an email with the model number of the product and a detailed description of your problem to: [accessorysupport@philips.com](mailto:accessorysupport@philips.com)

# 7 Glossary

---

## A

### **Amplifier**

A device, either a single stage or a large scale circuit with multiple stages for creating gain, i.e. it makes small signals larger.

### **Antenna**

A device, such as a rod or wire, which picks up a received radio frequency signal or radiates a transmitted RF signal.

---

## C

### **Coaxial**

A single copper conductor, surrounded with a layer of insulation, covered by a surrounding copper shield and finally, an insulating jacket. An unbalanced transmission line with constant impedance. In audio, this type is commonly used for low level, line signals terminated in RCA connectors.

---

## D

### **DVB (Digital Video Broadcasting)**

DVB is a suite of internationally accepted open standards for digital television.

---

## F

### **FM (Frequency Modulation)**

In radio broadcasting: a method of modulation in which the frequency of the carrier voltage is varied with the frequency of the modulation voltage.

---

## H

### **HDTV (High-Definition Television)**

It is a digital television broadcasting system with higher resolution than traditional

television systems (standard-definition TV, or SDTV). HDTV is digitally broadcast; the earliest implementations used analog broadcasting, but today digital television (DTV) signals are used, requiring less bandwidth due to digital video compression.

---

## U

### **UHF (Ultra high frequency)**

In radio or TV broadcasting: it is the frequency range of electromagnetic waves which lies between 300 MHz and 3 GHz (3000 MHz).

---

## V

### **VHF (Very high frequency)**

In radio or TV broadcasting: it is the frequency range of electromagnetic waves which lies between 30 MHz and 300 MHz.



